

Chapter 12: Surface Area and Volume

Find the lateral area and surface area of each figure. Round your answers to the nearest hundredth, if necessary.

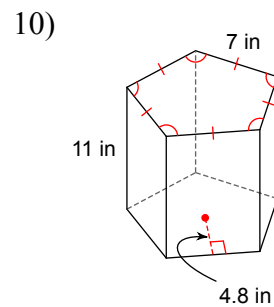

11)

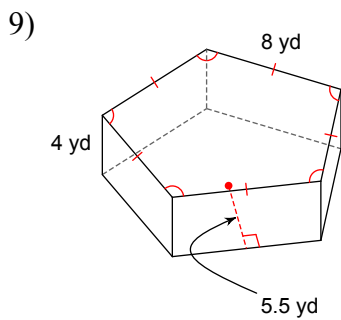
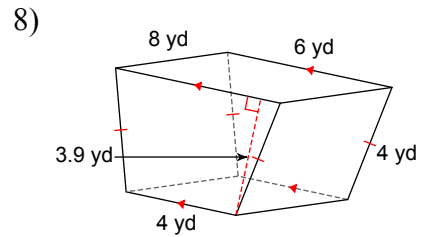
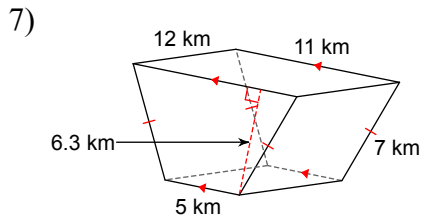
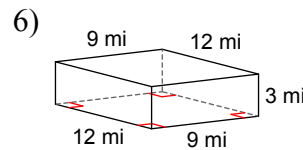
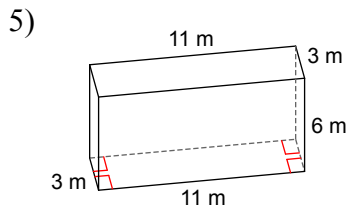
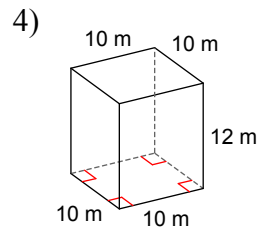
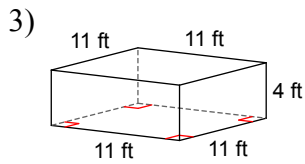
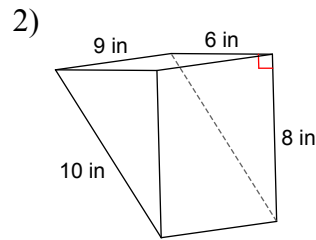
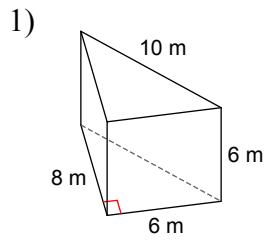
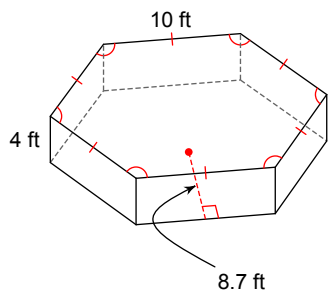

12)

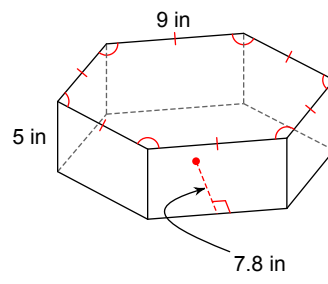

13)

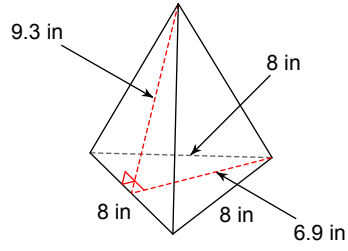

14)

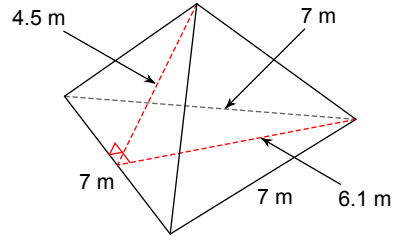

15)

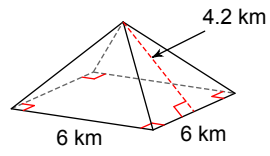

16)

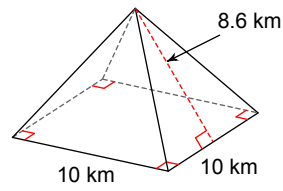

17)

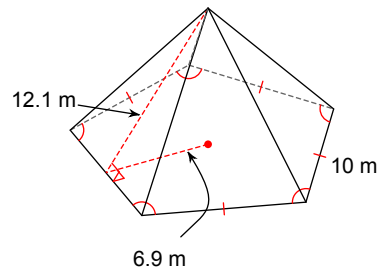

18)

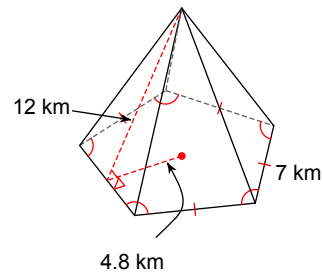

19)

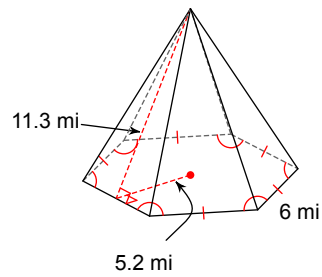

20)

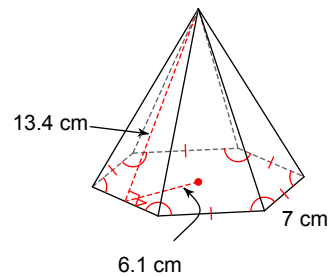

21)

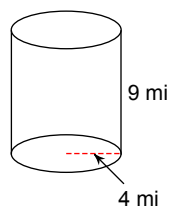

22)

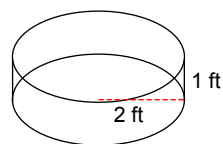

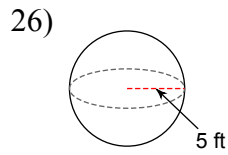
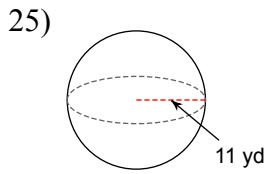
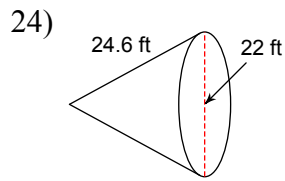
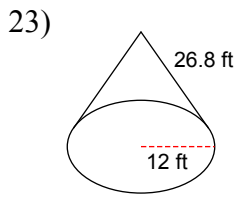

Find the volume of each figure. Round your answers to the nearest hundredth, if necessary.

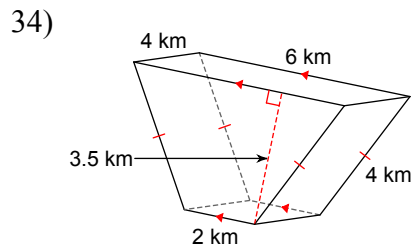
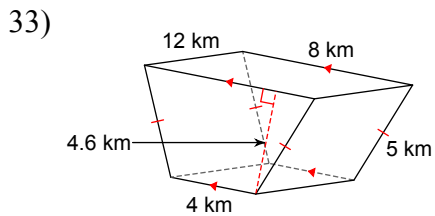
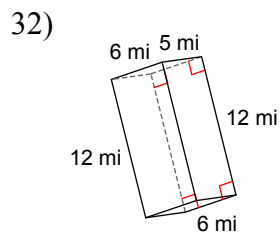
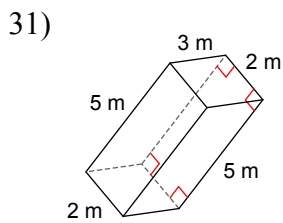
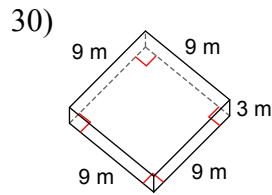
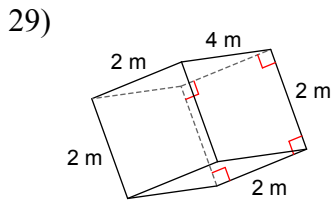
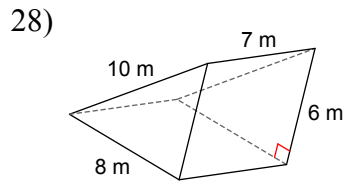
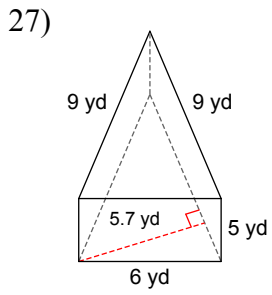

35)

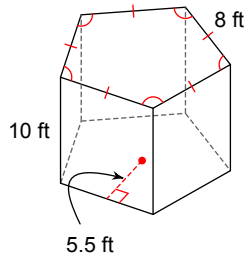

36)

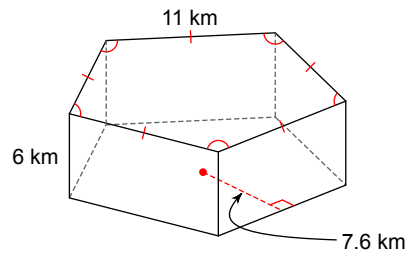

37)

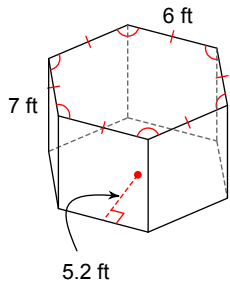

38)

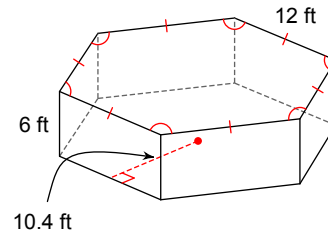

39)

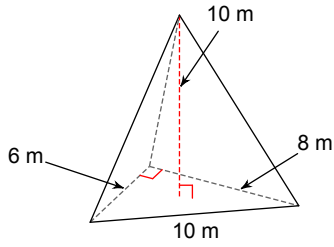

40)

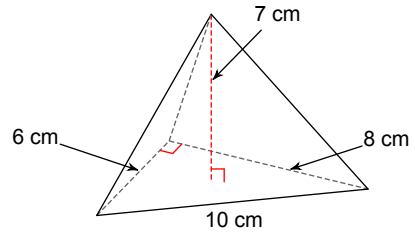

41)

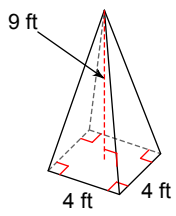

42)

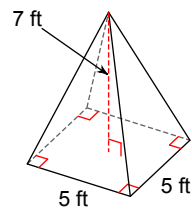

43)

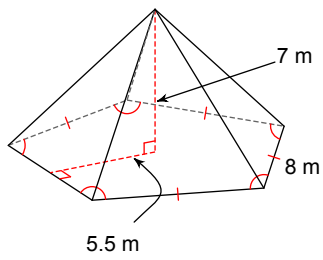

44)

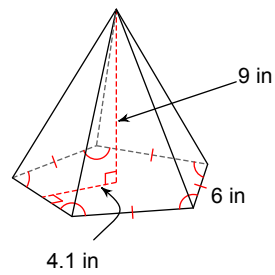

45)

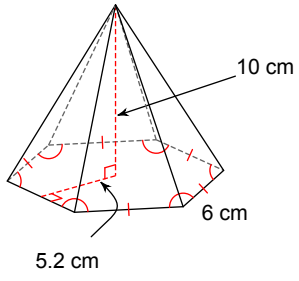

46)

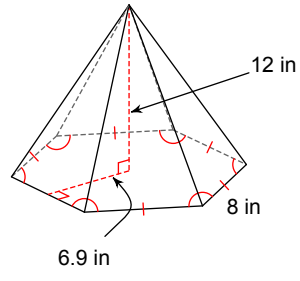

47)

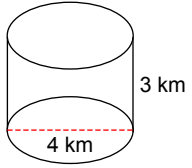

48)

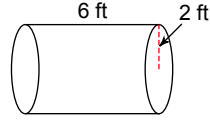

49)

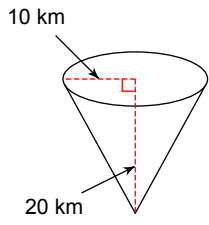

50)

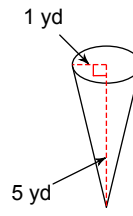

51)

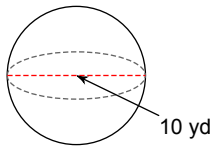

52)

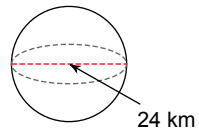

Answers to Chapter 12: Surface Area and Volume (ID: 2)

- | | | | |
|---|--|--|---|
| 1) 144 m^2 ; 192 m^2 | 2) 216 in^2 ; 264 in^2 | 3) 176 ft^2 ; 418 ft^2 | 4) 480 m^2 ; 680 m^2 |
| 5) 168 m^2 ; 234 m^2 | 6) 126 mi^2 ; 342 mi^2 | 7) 360 km^2 ; 460.8 km^2 | 8) 144 yd^2 ; 183 yd^2 |
| 9) 160 yd^2 ; 380 yd^2 | 10) 385 in^2 ; 553 in^2 | 11) 240 ft^2 ; 762 ft^2 | 12) 270 in^2 ; 691.2 in^2 |
| 13) 111.6 in^2 ; 139.2 in^2 | 14) 47.25 m^2 ; 68.6 m^2 | 15) 50.4 km^2 ; 86.4 km^2 | |
| 16) 172 km^2 ; 272 km^2 | 17) 302.5 m^2 ; 475 m^2 | 18) 210 km^2 ; 294 km^2 | 19) 203.4 mi^2 ; 297 mi^2 |
| 20) 281.4 cm^2 ; 409.5 cm^2 | 21) 226.19 mi^2 ; 326.73 mi^2 | 22) 12.57 ft^2 ; 37.7 ft^2 | |
| 23) 1010.34 ft^2 ; 1462.73 ft^2 | 24) 850.11 ft^2 ; 1230.25 ft^2 | 25) None; 1520.53 yd^2 | |
| 26) None; 314.16 ft^2 | 27) 128.25 yd^3 | 28) 168 m^3 | 29) 16 m^3 |
| 30) 243 m^3 | 31) 30 m^3 | 32) 360 mi^3 | 33) 331.2 km^3 |
| 34) 56 km^3 | 35) 1100 ft^3 | 36) 1254 km^3 | 37) 655.2 ft^3 |
| 38) 2246.4 ft^3 | 39) 80 m^3 | 40) 56 cm^3 | 41) 48 ft^3 |
| 42) 58.33 ft^3 | 43) 256.67 m^3 | 44) 184.5 in^3 | 45) 312 cm^3 |
| 46) 662.4 in^3 | 47) 37.7 km^3 | 48) 75.4 ft^3 | 49) 2094.4 km^3 |
| 50) 5.24 yd^3 | 51) 523.6 yd^3 | 52) 7238.23 km^3 | |